



Installation Instructions

Eibach Springs, Inc. • 264 Mariah Circle • Corona, California 92879-1751 • USA • Tech Support 800-222-8811 Ext 114

PRO-LIFT # E30-59-005-02-02

2003-2009 Lexus GX470

Note: The Pro Truck Leveling rear springs must not be used with the OE shocks. Extended travel shocks are required to avoid damage to the suspension.

Kit Contents	Description	Part Number	Qty
	Spring, Rear	F31-59-005-02-RA	2
	Upper Spring Perch Adapter	8001271	2
	Lower Spring Locator	8001288	2
	Screw, Hex M12-1.75 x 40mm L	H13025576	2
	Nut, M12-1.75 Nylock	H63025500	4
	Washer, M12 Flat	H50025200	2
	Washer, Fender	H57085200	2
	Screw, Hex, M12-1.75 x 30mm L	H13155542	2
	Zip Tie	H70065500	1
	Instructions	E30-59-005-02-02INST	1

NOTES: Read All Instructions Before Beginning Installation

- Only qualified mechanics experienced in the installation and removal of suspension components should perform this installation.
- Use of a hoist is highly recommended and will substantially reduce installation time.
- Never work on or under a vehicle unless it is properly supported by safety stands and wheels are blocked.
- Never use impact wrenches or impact guns to install or remove shock absorber piston components, shafts and piston rod nuts.
- PRO-LIFT springs should be installed with the Eibach Logo right side up. All original stock spring isolators, dampers and tubing should be retained from the stock springs and used when installing the PRO-LIFT Springs.
- After installation, it is always important to inspect and adjust the following if necessary:
 - Wheel alignment such as camber, caster & toe
 - Tire and/or wheel fender clearance, when aftermarket tires and wheels are used.
 - Brake line clearance and attachments
 - Brake anti-locking and anti-skid system sensors
- **Tire Rotation:** In order to increase the life of your tires, it is recommended to rotate your tires every 3,000 miles.

Weight	Lift
0 lbs	3.25"
100 lbs	3.0"
200 lbs	2.75"
300 lbs	2.5"
400 lbs	2.25"

**Heights shown are an approximate.
Vehicle condition and load
distribution will vary lift heights**

Rear Suspension Removal and Installation

1. Raise the rear of the vehicle until the wheels are off the ground and the suspension is fully unloaded. **Note: Never work on or under a vehicle that is not supported by the proper safety equipment.**

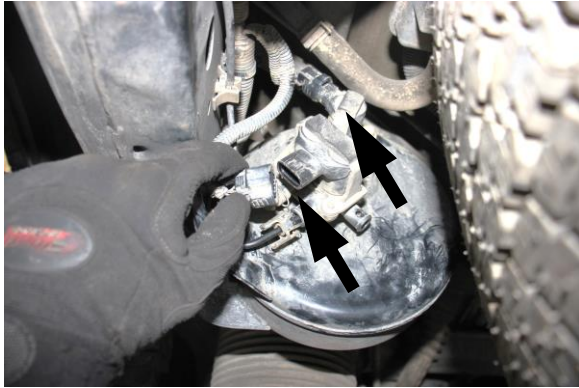

Photo 1

2. Disconnect the air compressor electric connections as shown. (See Photo 1)



Photo 2

3. Disconnect the air lines from the compressor as shown. (See Photo 2)



Photo 3



Photo 4

4. Unclip the air bag air lines from the frame as shown. (See Photos 3 & 4)



Photo 5

5. Loosen and remove the hardware that secures the end link to the anti-roll bar, then, disconnect the end link from the bar. (See Photo 5)



Photo 6



Photo 7



Photo 8

6. Support the rear axle with a screw jack and disconnect the shock electrical connection, then, loosen and remove the hardware that secures the upper and lower shock mounts and remove the shock from the vehicle. (See Photos 6, 7 & 8)



Photo 9

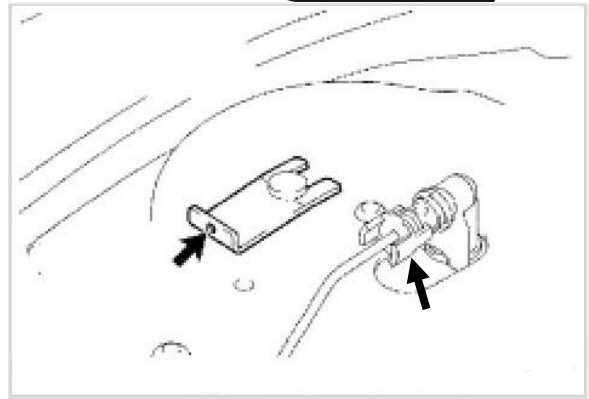

Photo 10

7. Located on top of the spring pocket, disengage and remove the spring clip retainer, also disconnect the air line. (See Photos 9 & 10)

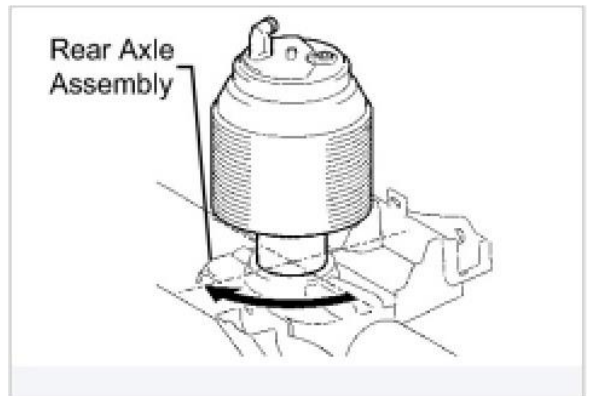
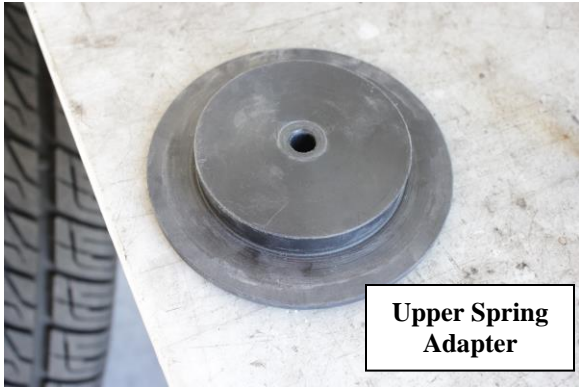

Photo 11



Photo 12

8. Lower the axle downward to remove some pressure from the air ride assembly, then, rotate the assembly 90 degrees to release the lower mount, then, remove the assembly and air lines as shown. (See Photos 11 & 12)



Upper Spring Adapter

Photo 13

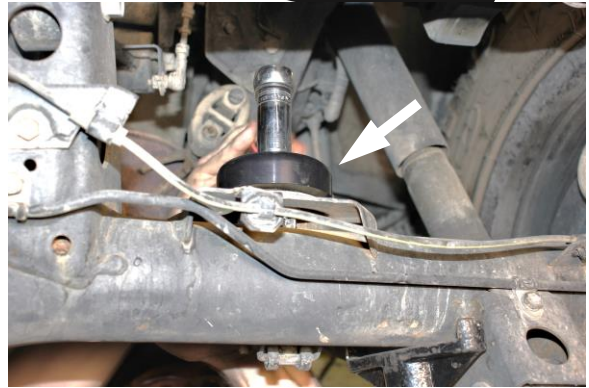

Photo 16

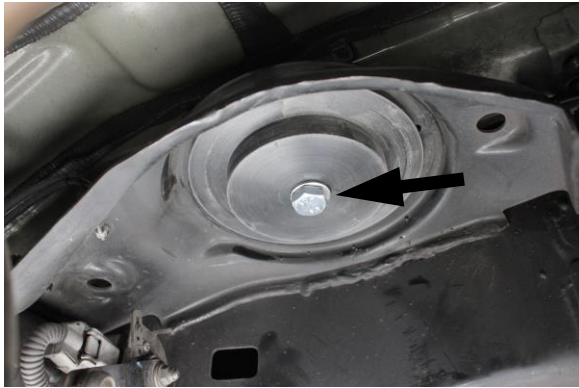

Photo 14



Photo 17

9. Install the upper spring mount adapter using the provided M12-1.75 x 30mm L hex screw and M12 washer and nylock nut as shown. (See Photos 13 & 14)

10. Secure the lower spring mount adapter to the axle using the provided M12-1.75 x 40mm L hex screw and M12 washer and nylock nut as shown. (See Photos 15, 16 & 17)

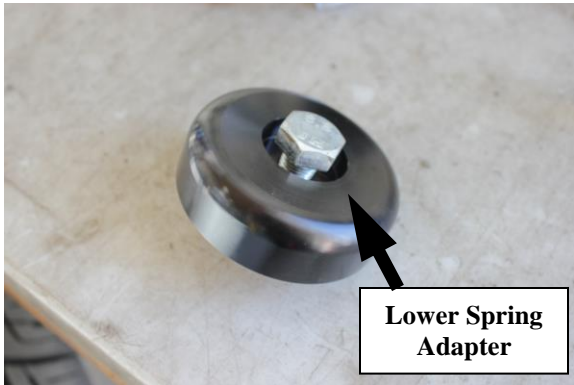

Lower Spring Adapter

Photo 15



Photo 18



Photo 19



Photo 20

11. Install the rear spring making sure the spring lines up with the upper and lower adapters, then, raise the suspension upwards as shown. (See Photos 18, 19 & 20)

12. Install your new extended length shocks.



Photo 21

13. Reconnect and secure the OE end links with the OE hardware. (See Photo 21)



Photo 22

14. Secure the air compressor electrical connections with the provided zip ties. (See Photo 22)

15. Doublecheck to make sure everything is properly positioned and tightened.

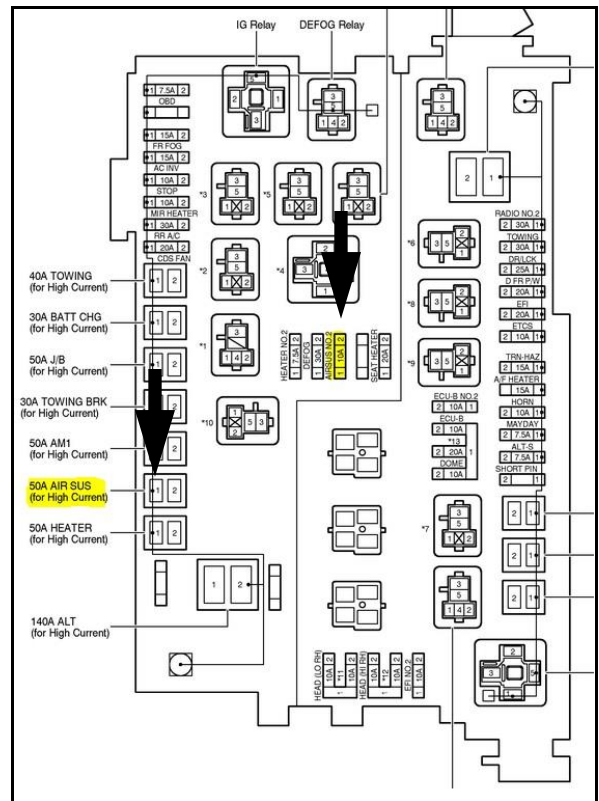

Photo 23

16. Remove the **50a Air Sus Relay** and the **Air Sus #2 10a fuse**, shown highlighted in yellow. (See Photo 23)

17. Road test the vehicle and re-tighten if necessary